

1

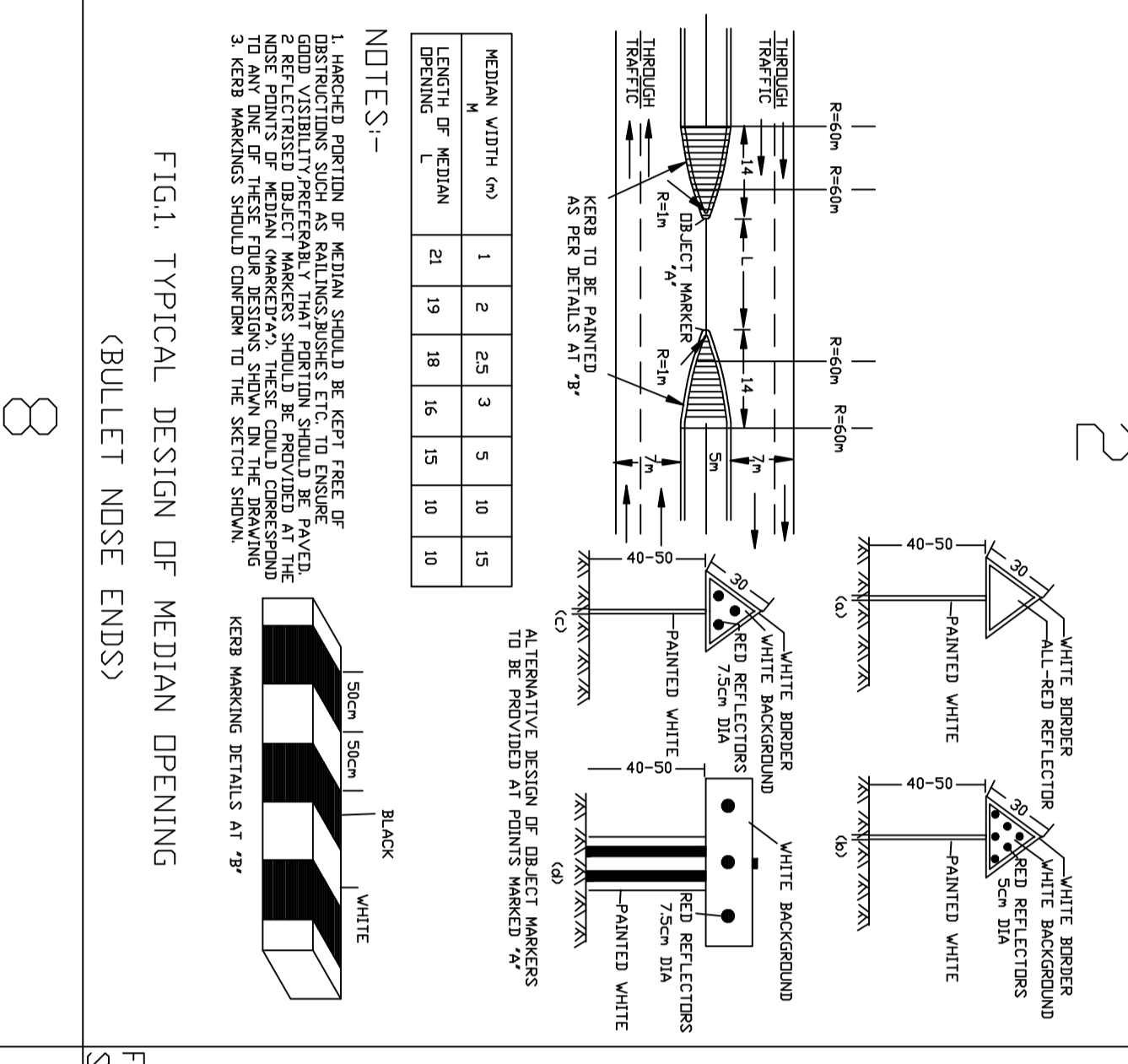

2

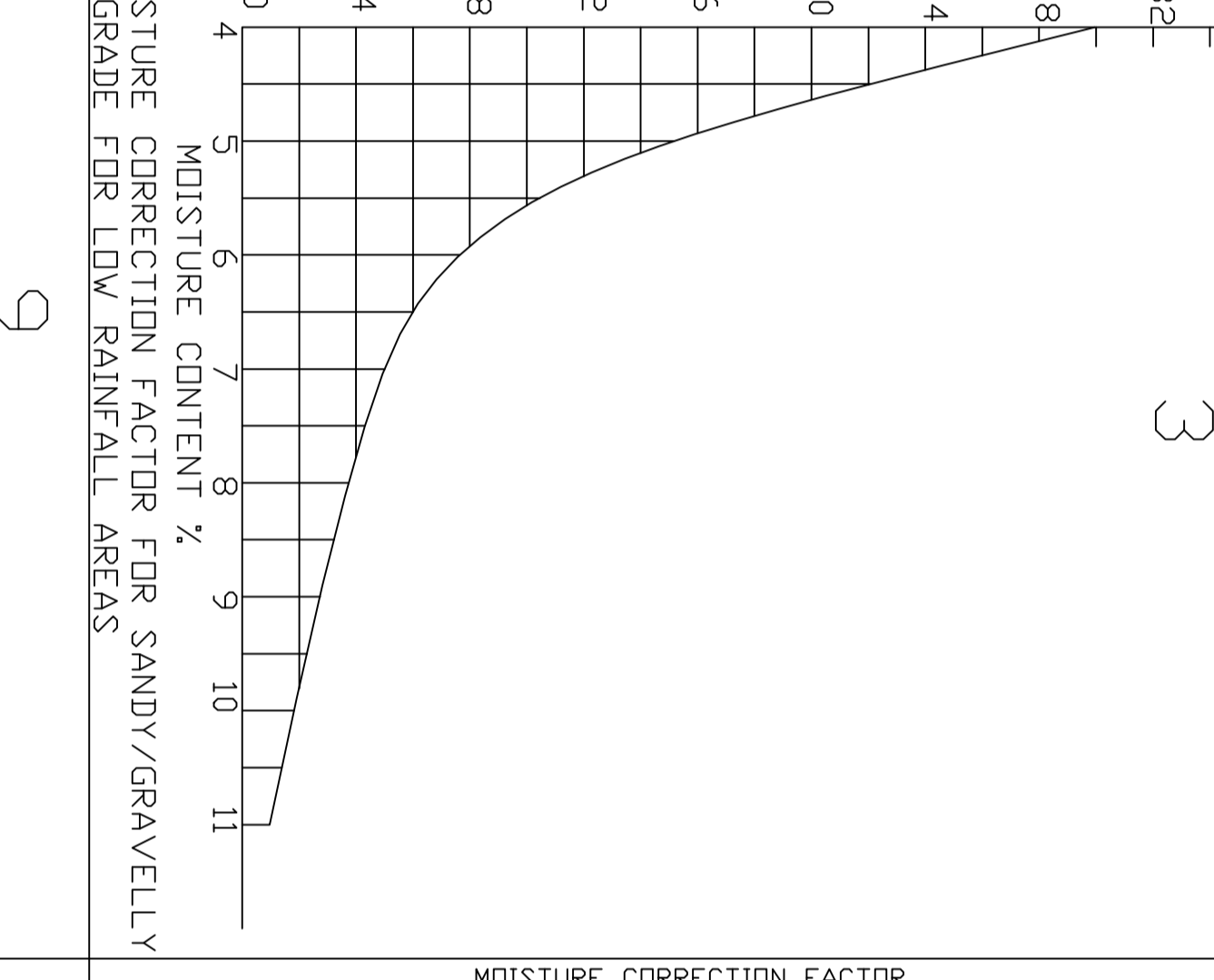

3

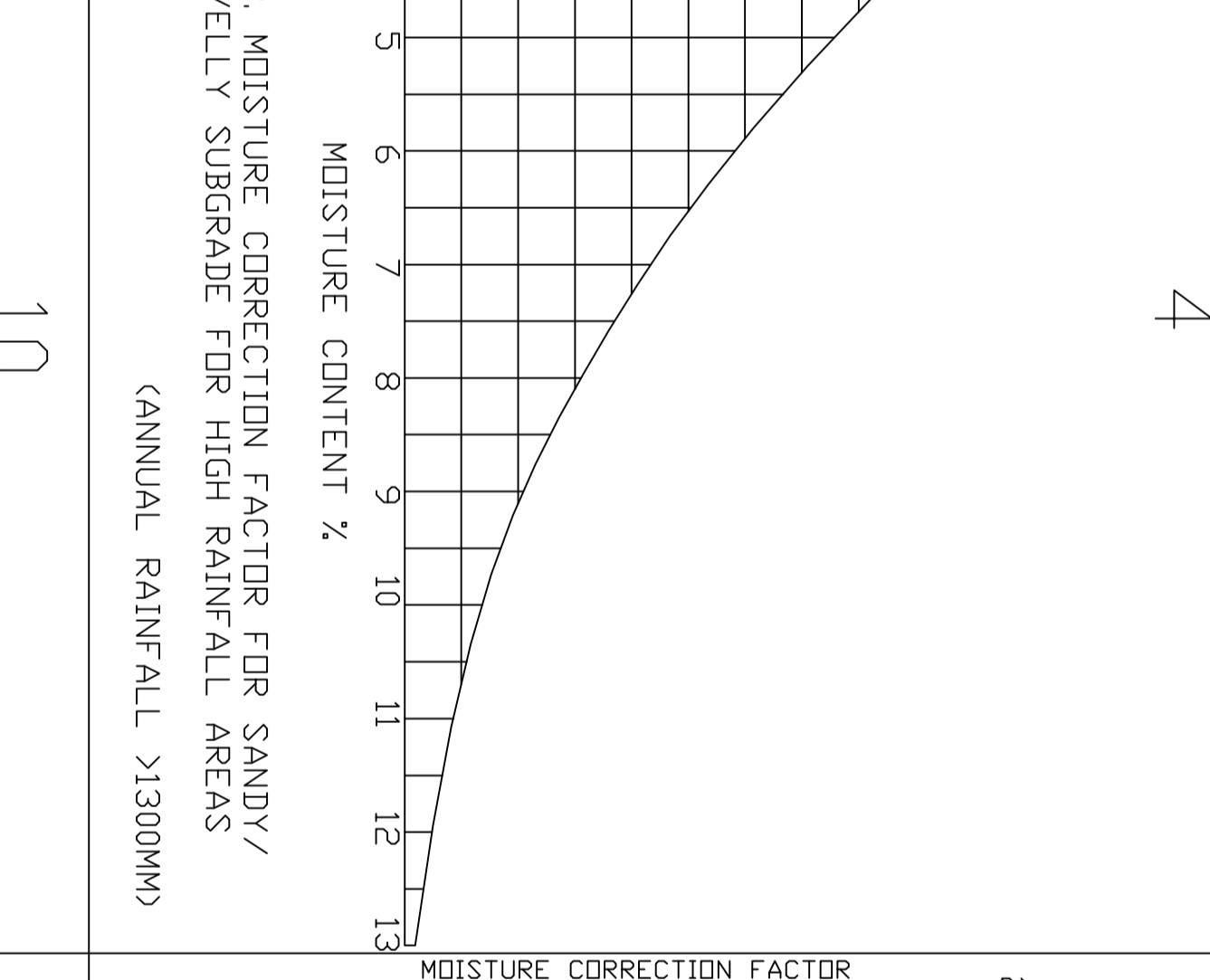

4

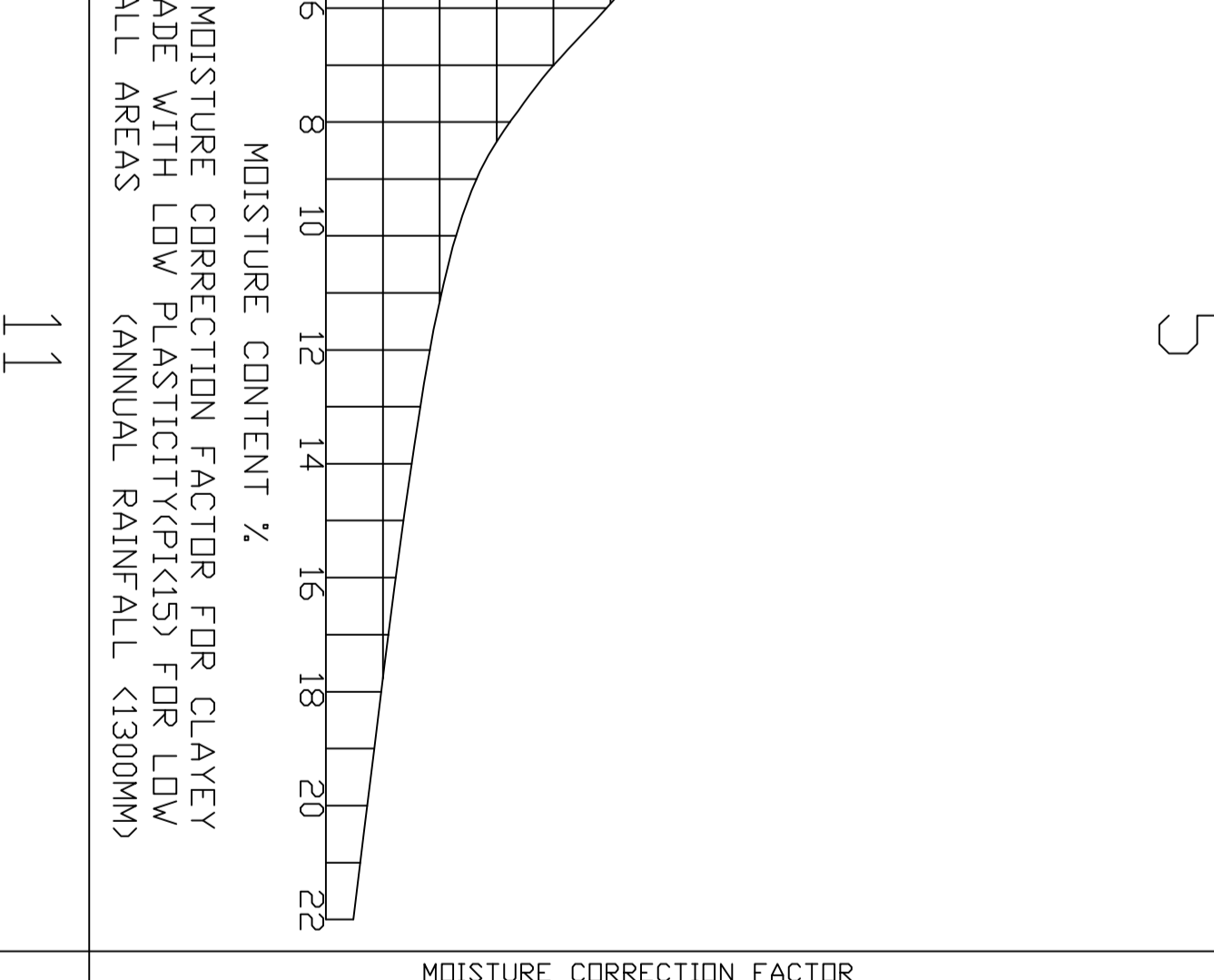

5

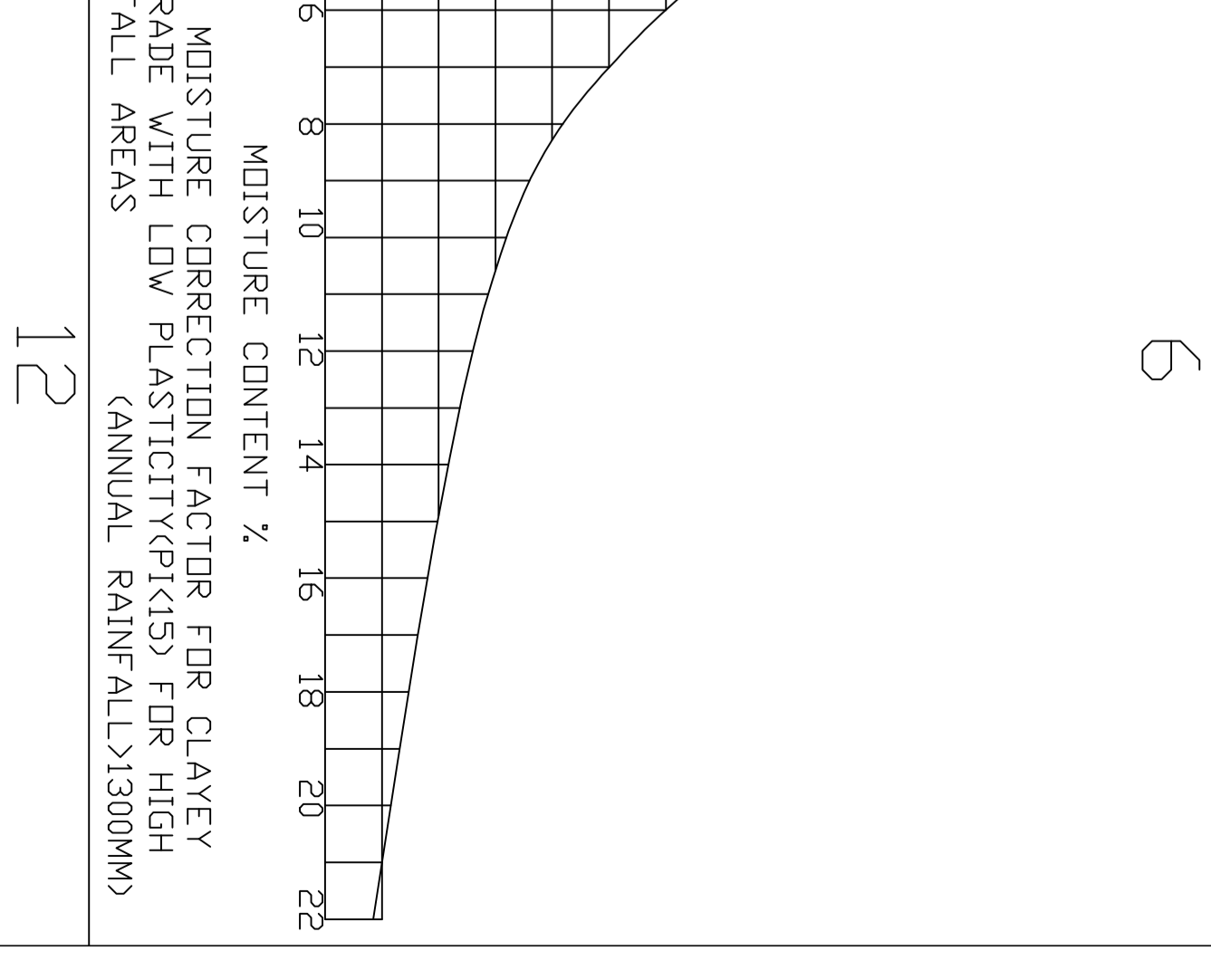

6

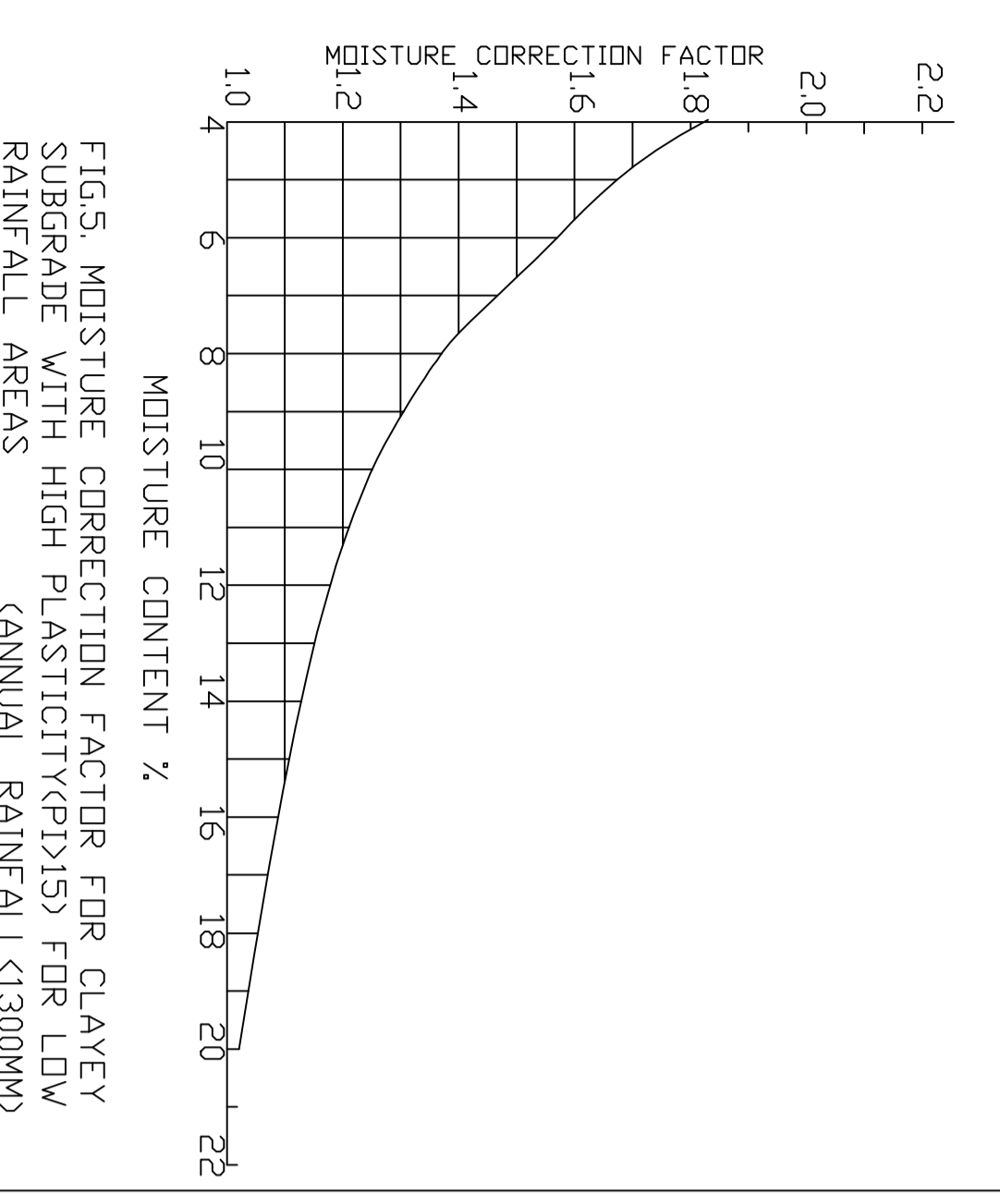

7

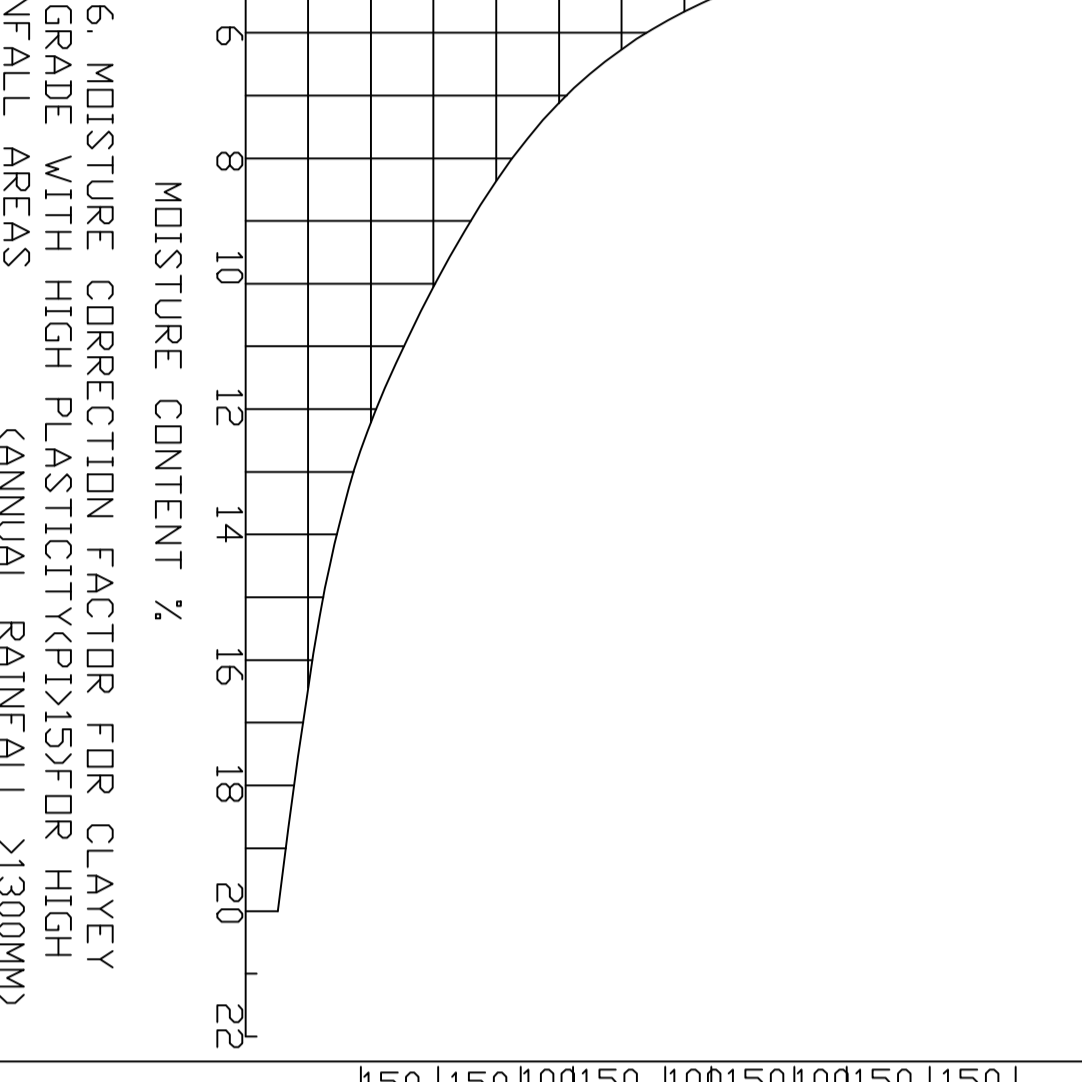

8

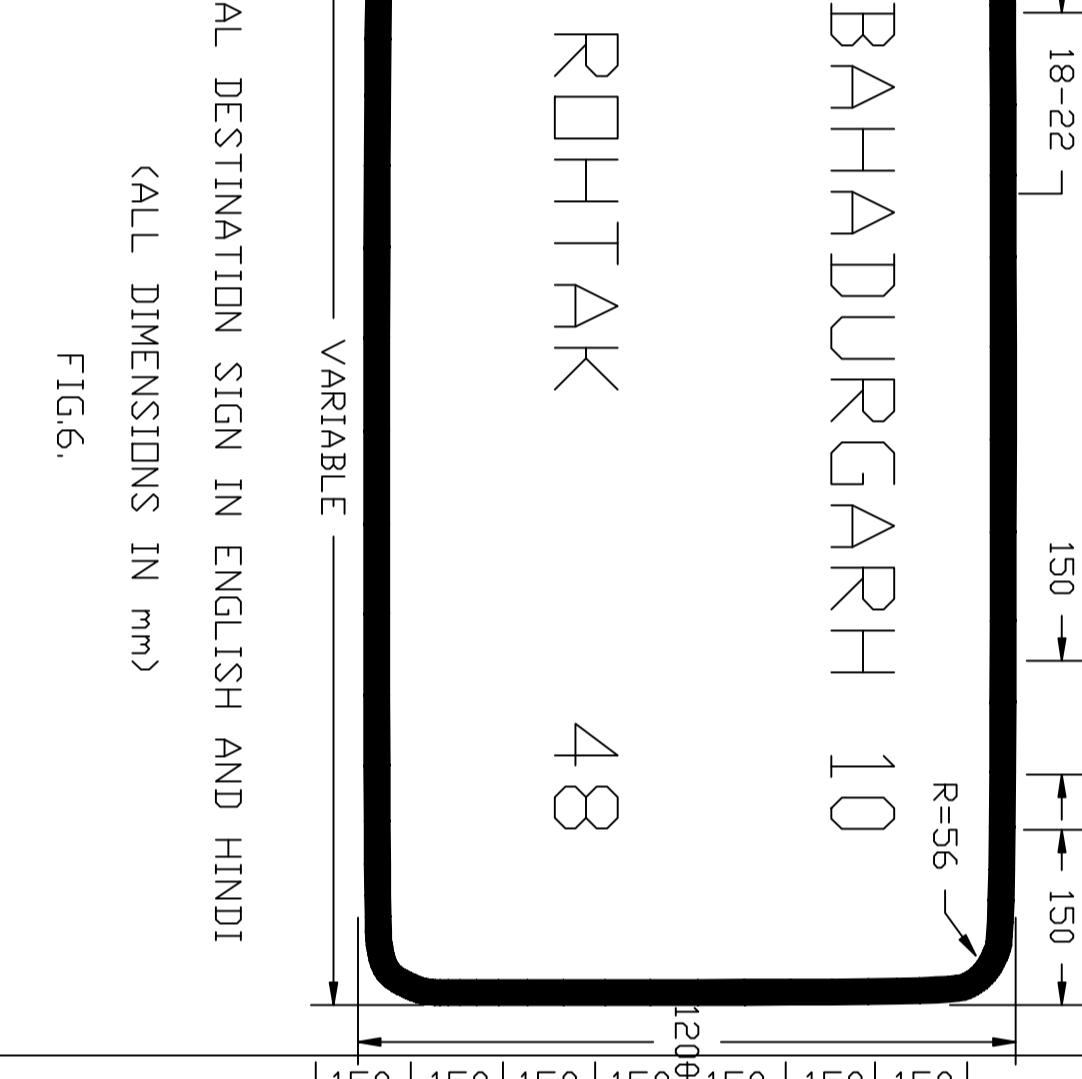

9

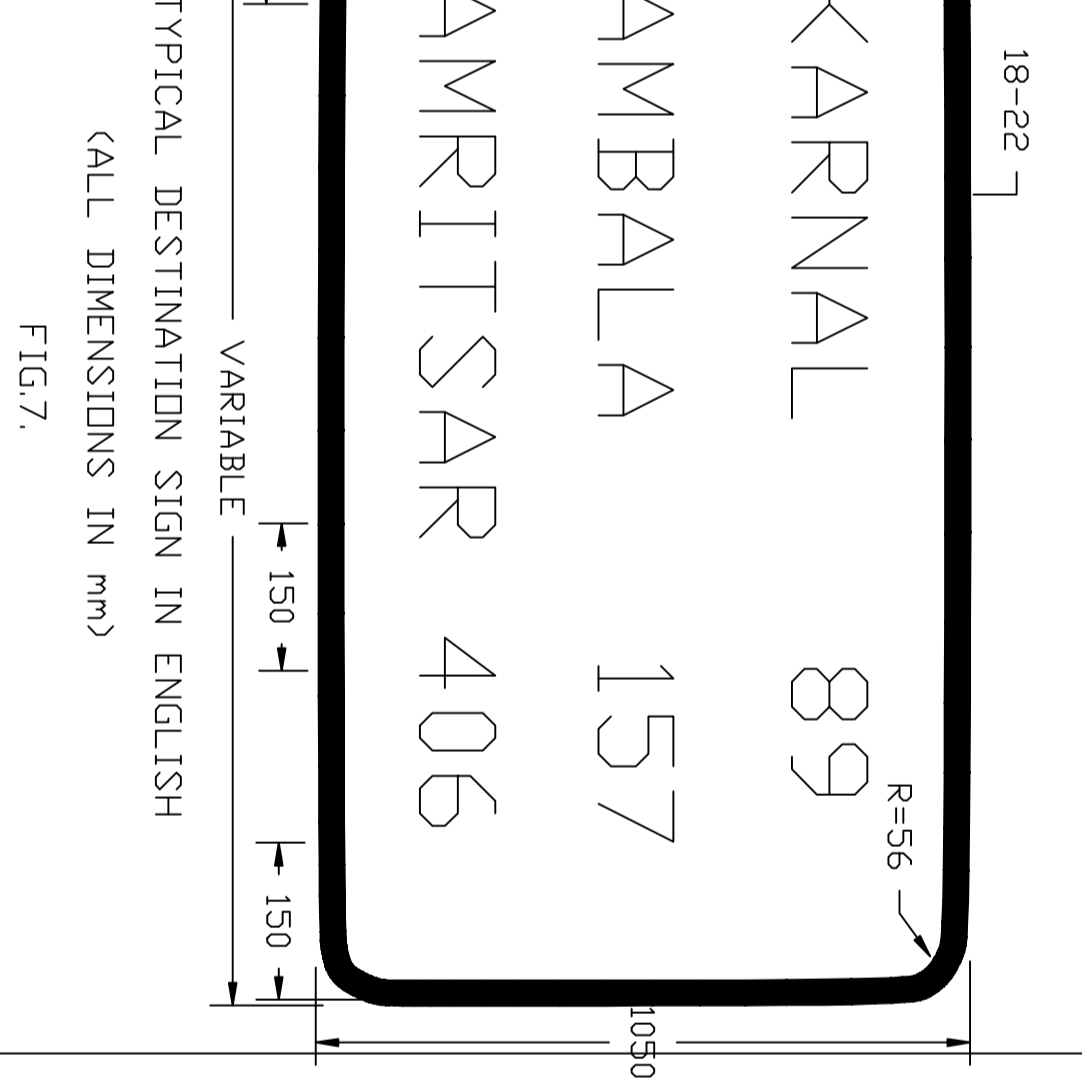

10

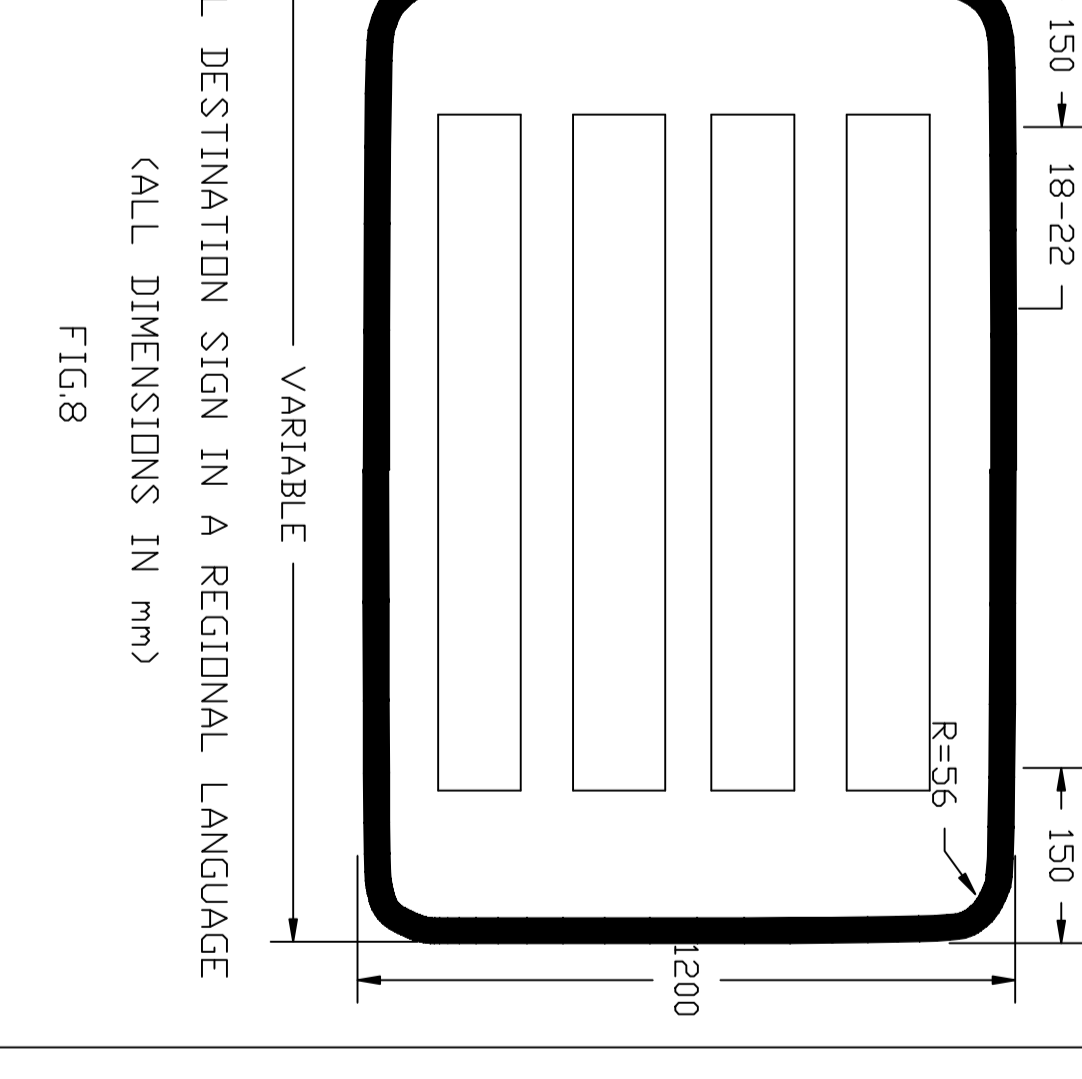

11

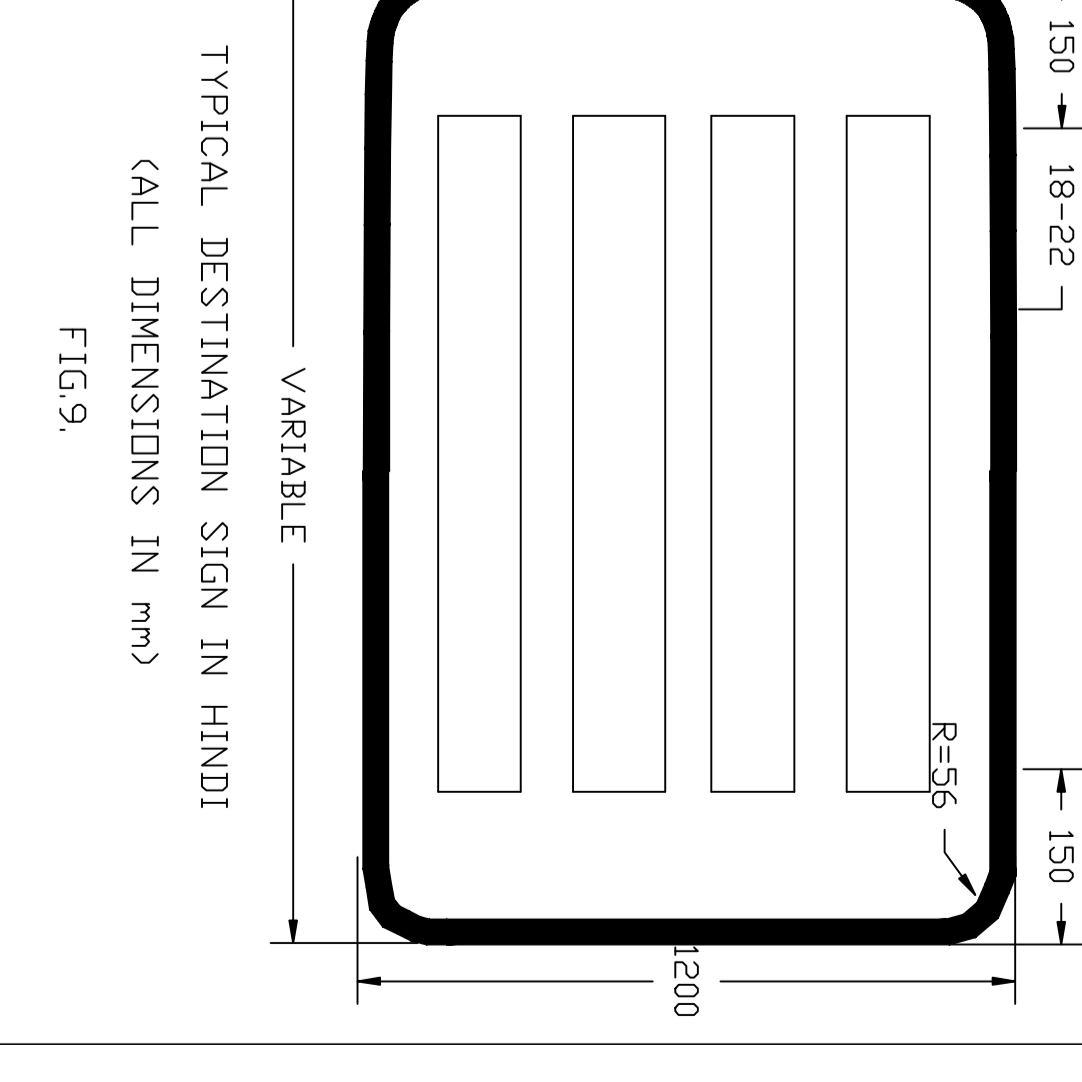

12

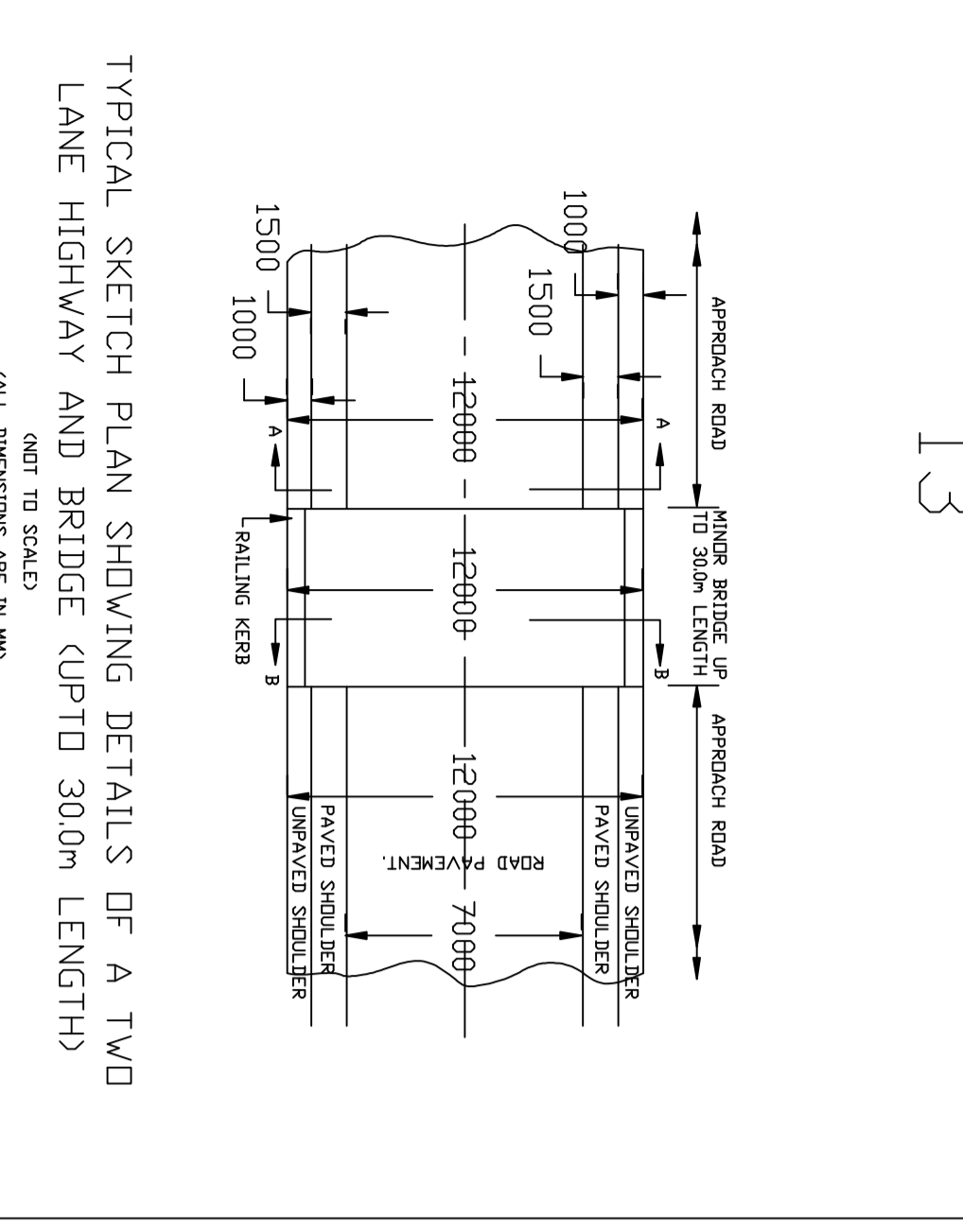

13

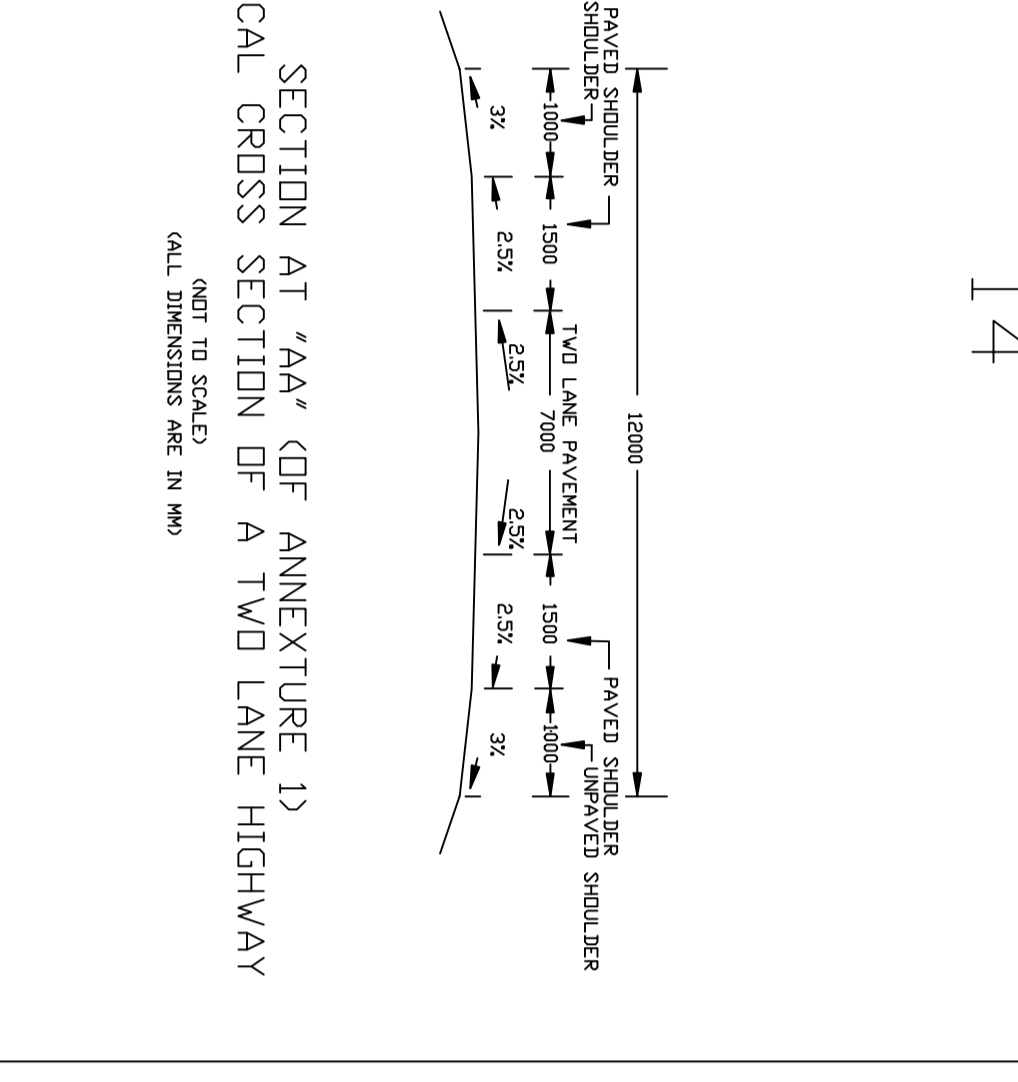

14

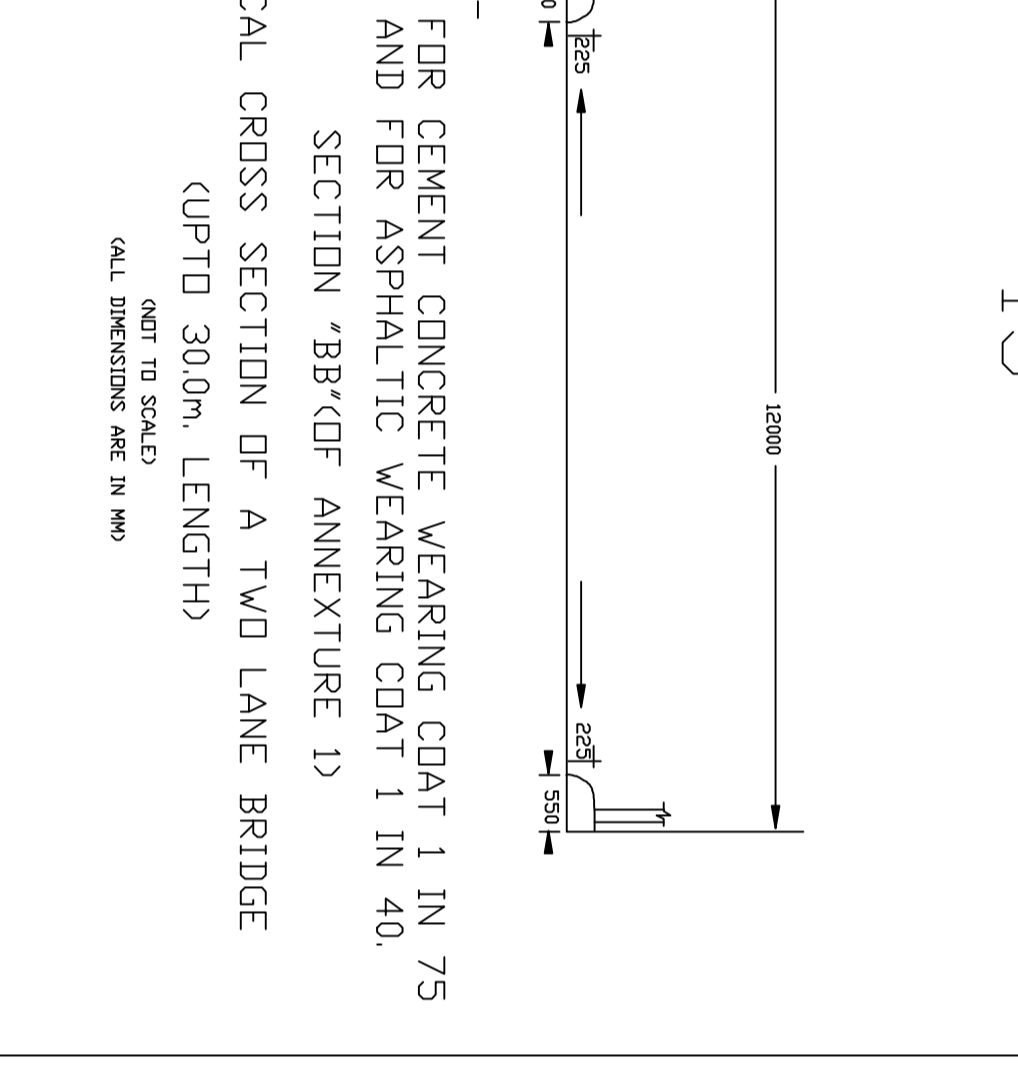

15

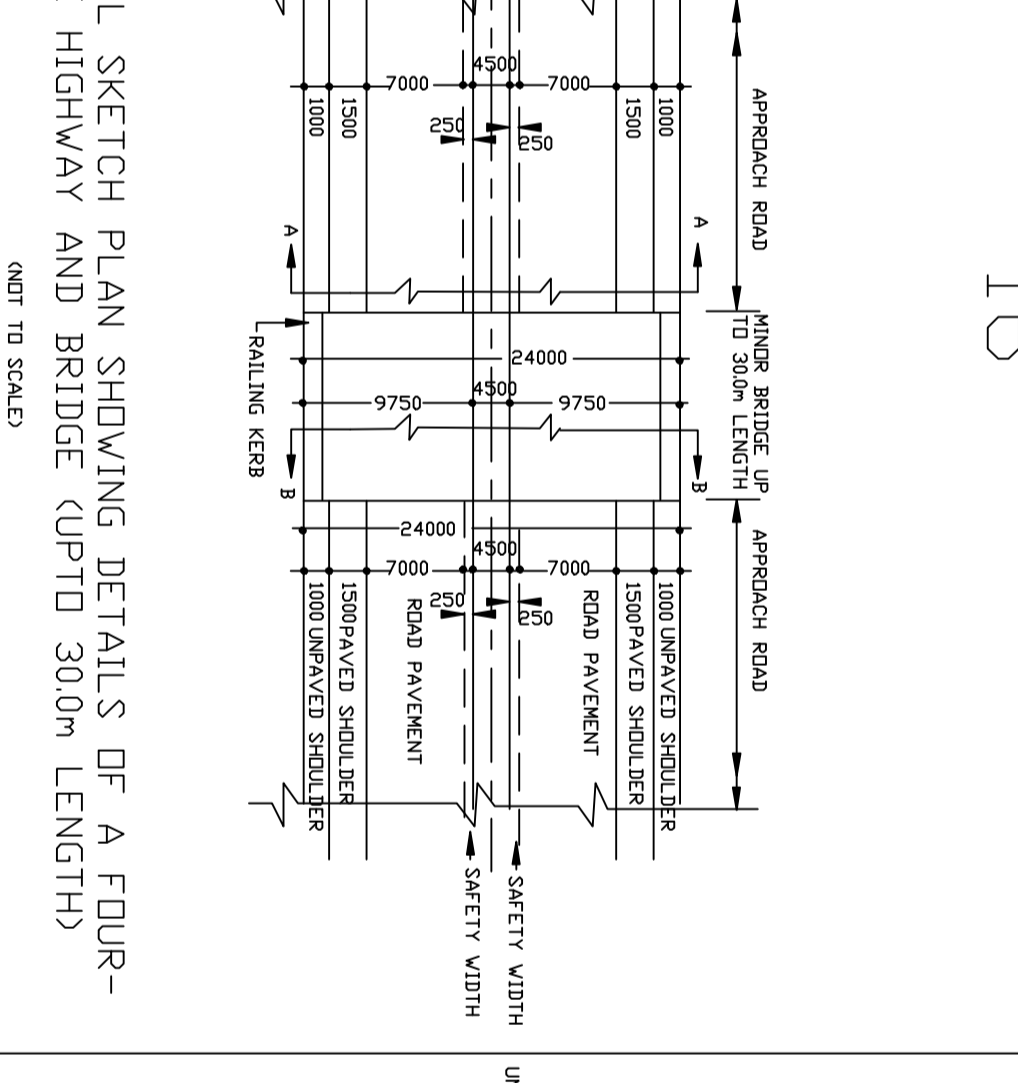

16

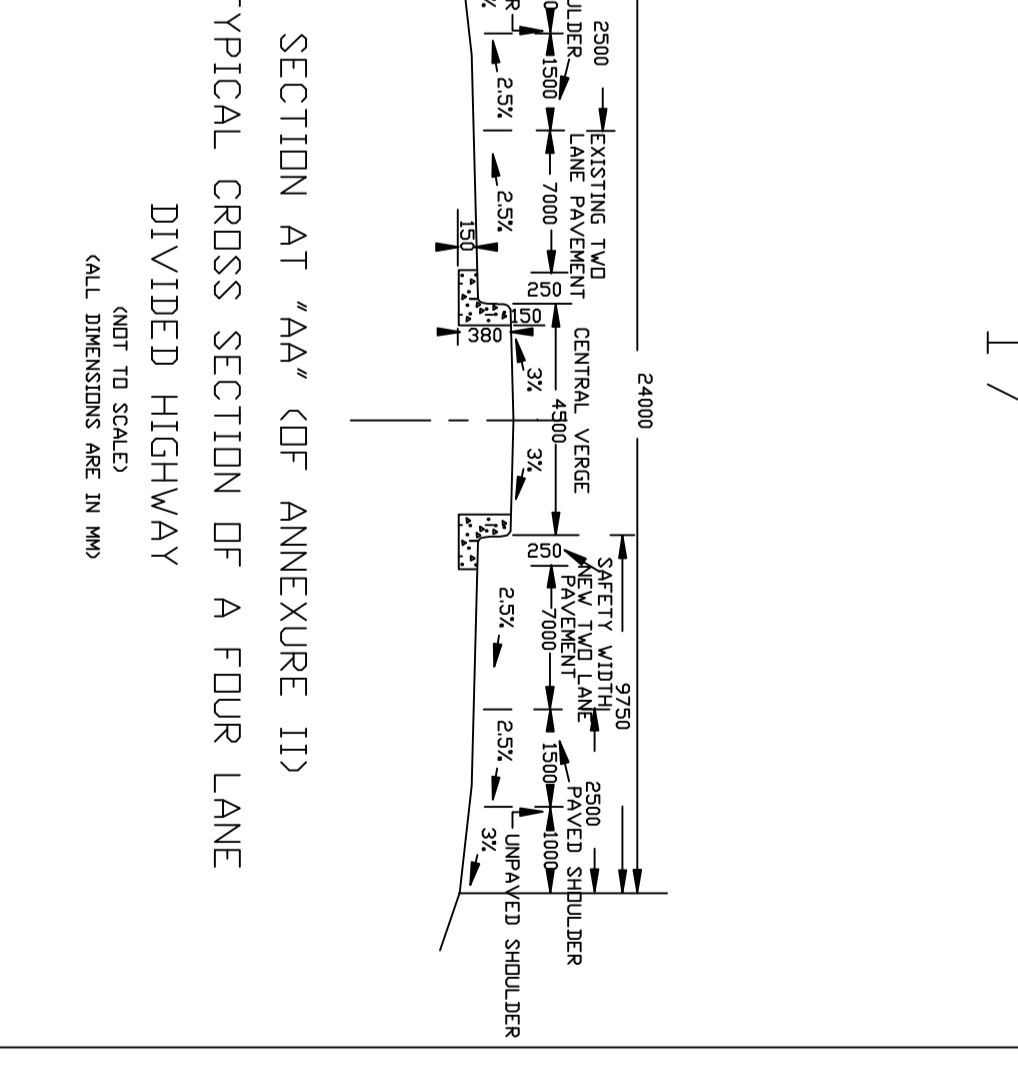

17

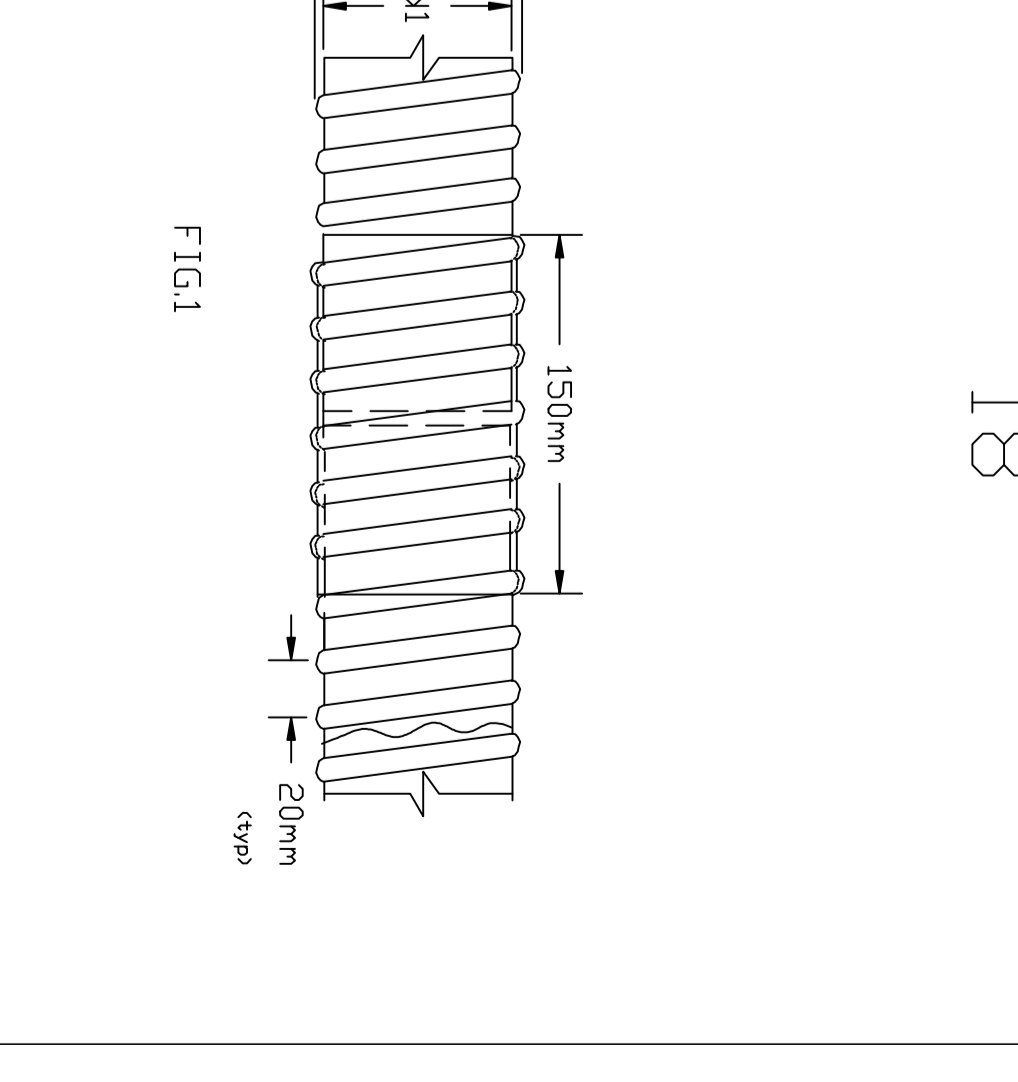

18

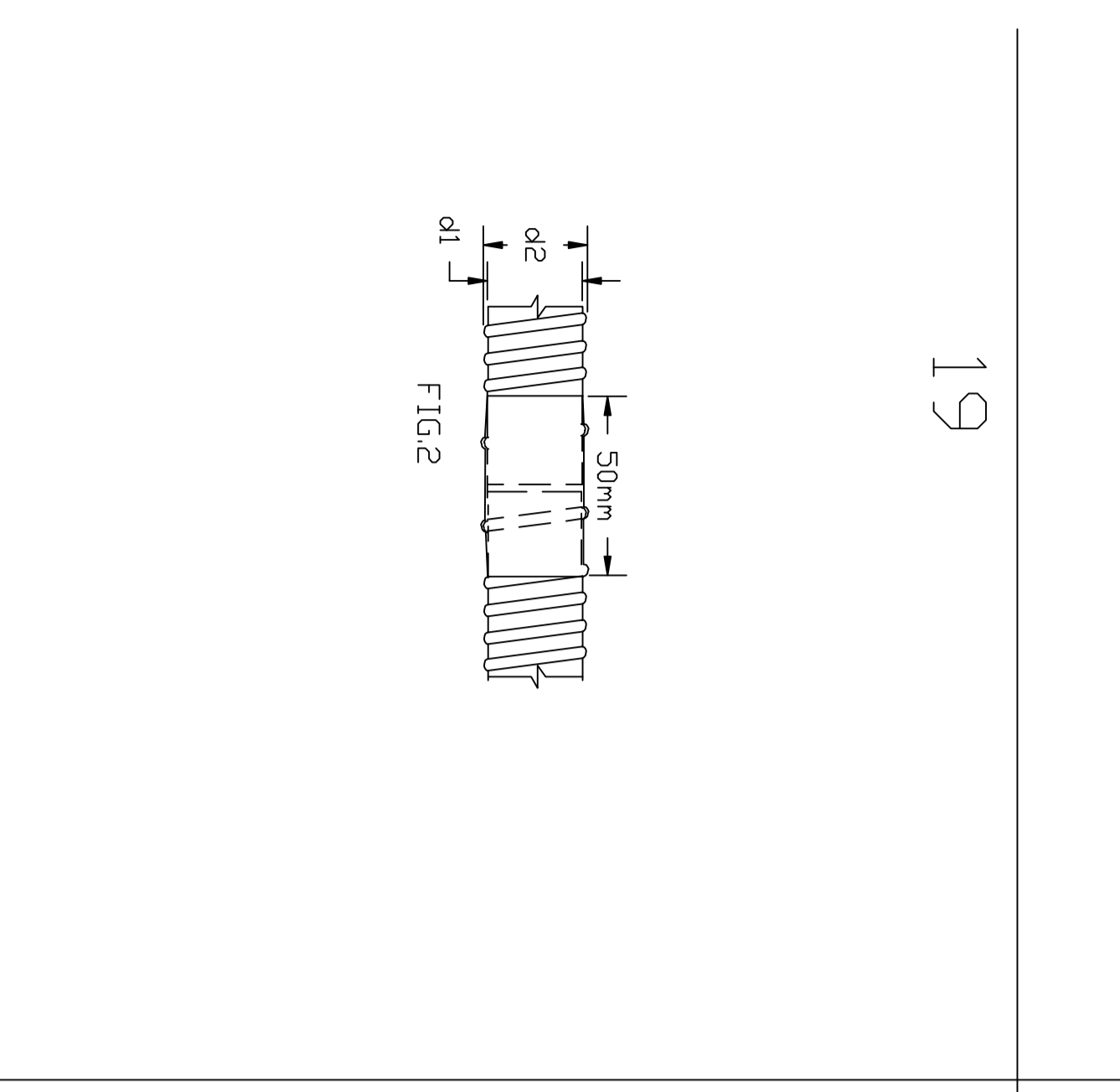

19

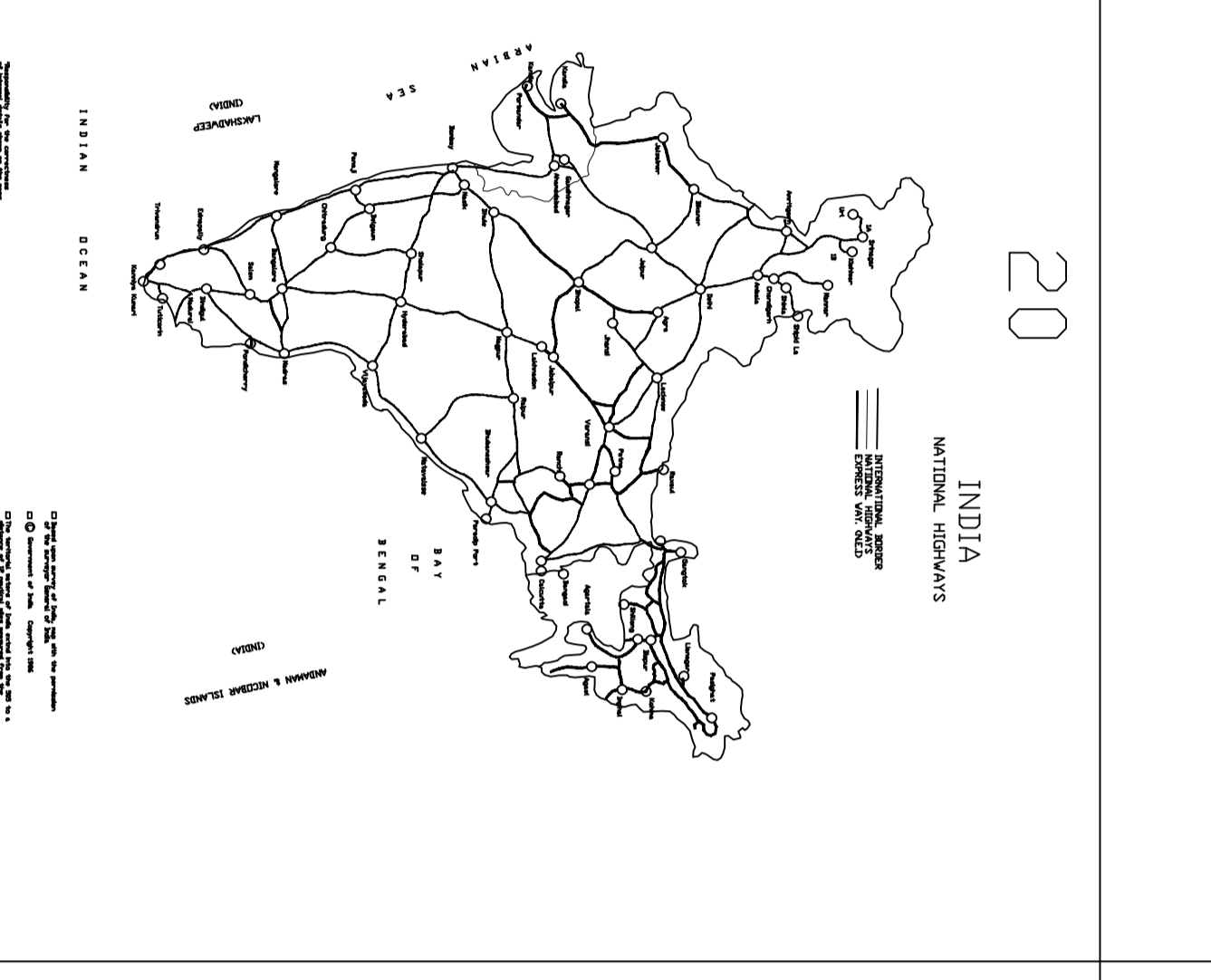

20

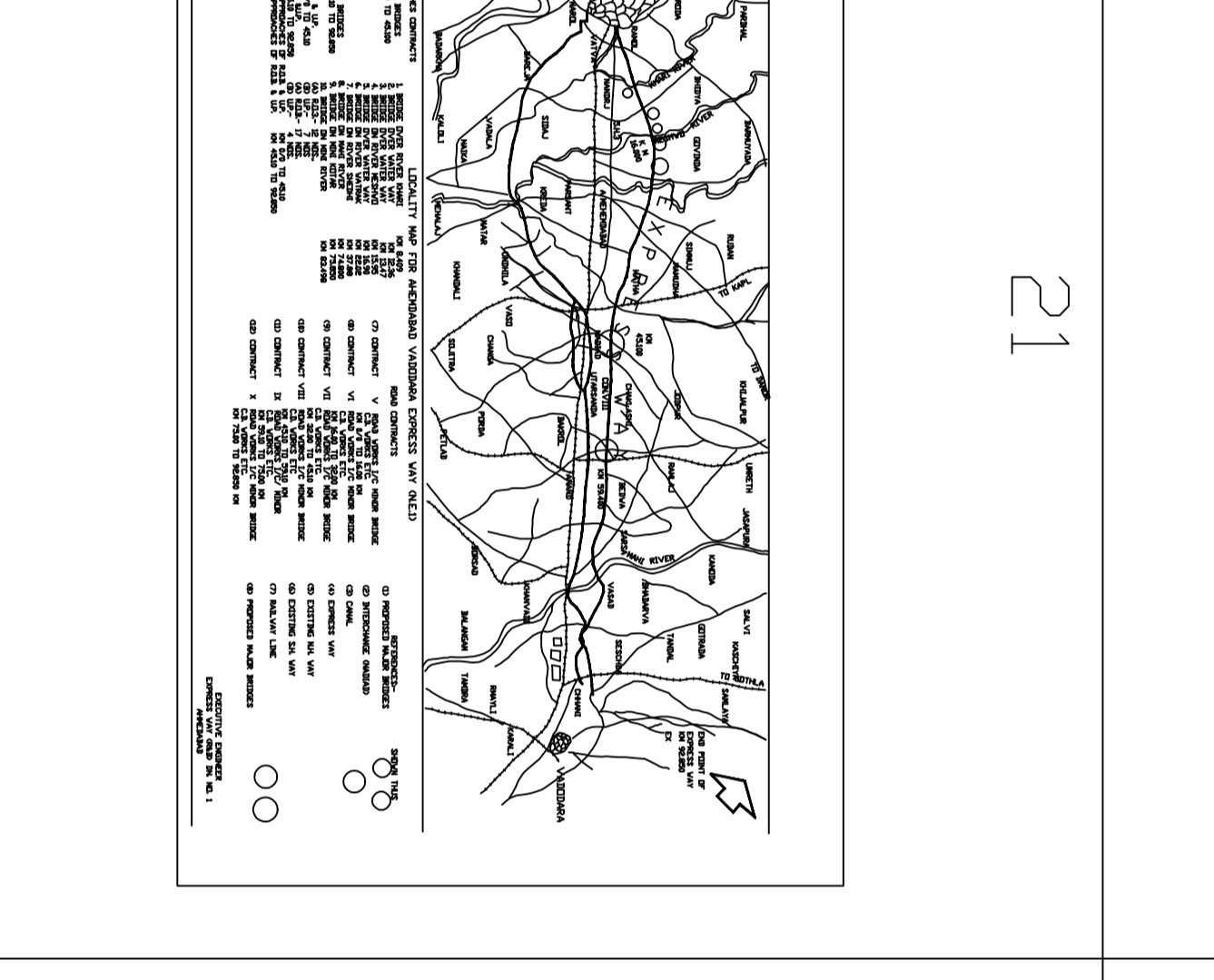

21

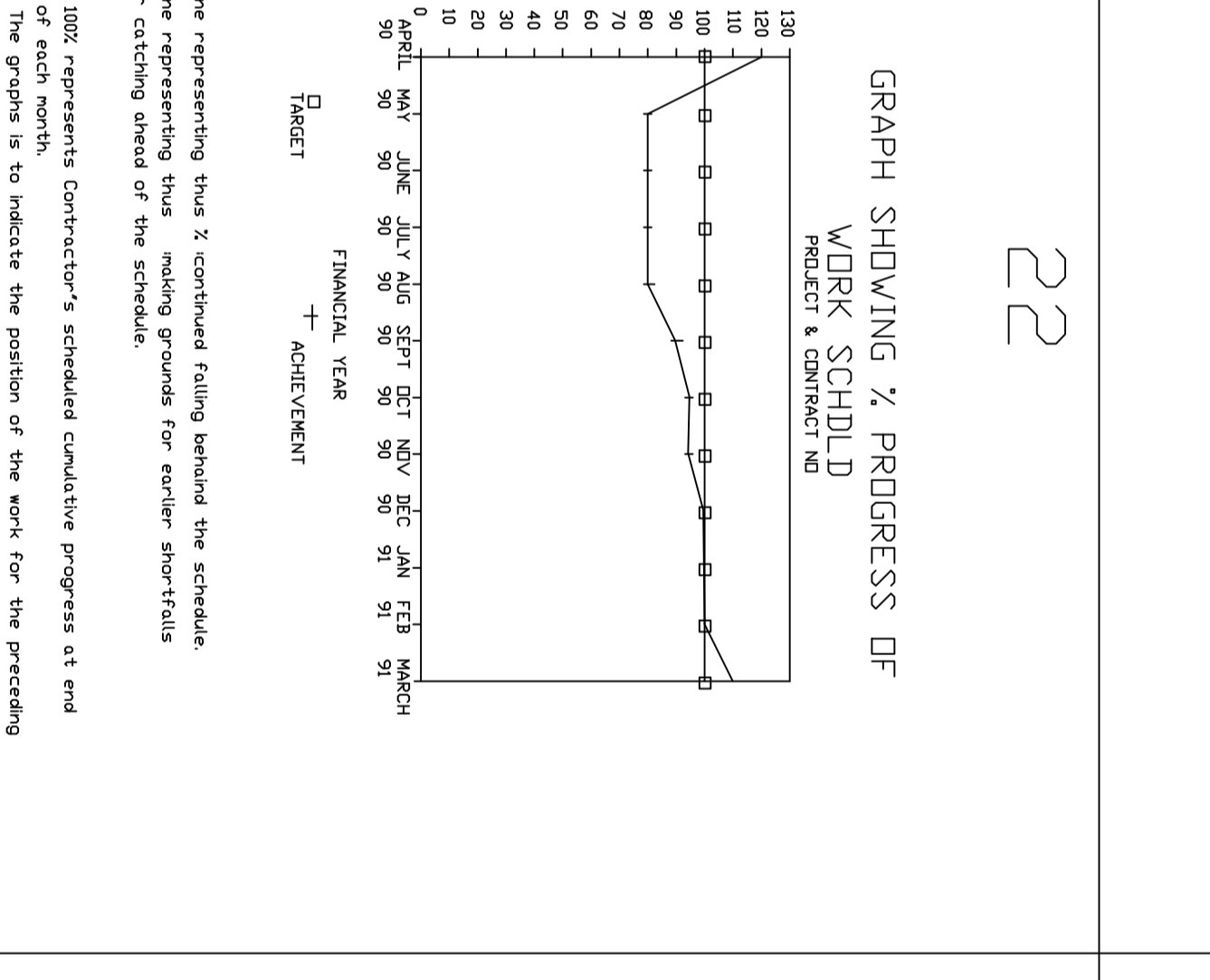

22

Sl. No.	Contract No.	Contract Name	Contract Value (Rs. Crores)	Contract Completion %
1	1001	...	...	...
2	1002	...	...	...
3	1003	...	...	...
4	1004	...	...	...
5	1005	...	...	...
6	1006	...	...	...
7	1007	...	...	...
8	1008	...	...	...
9	1009	...	...	...
10	1010	...	...	...

23

Sl. No.	Contract No.	Contract Name	Contract Value (Rs. Crores)	Contract Completion %
1	1011	...	...	...
2	1012	...	...	...
3	1013	...	...	...
4	1014	...	...	...
5	1015	...	...	...
6	1016	...	...	...
7	1017	...	...	...
8	1018	...	...	...
9	1019	...	...	...
10	1020	...	...	...

24

Sl. No.	Contract No.	Contract Name	Contract Value (Rs. Crores)	Contract Completion %
1	1021	...	...	...
2	1022	...	...	...
3	1023	...	...	...
4	1024	...	...	...
5	1025	...	...	...
6	1026	...	...	...
7	1027	...	...	...
8	1028	...	...	...
9	1029	...	...	...
10	1030	...	...	...

25

Sl. No.	Contract No.	Contract Name	Contract Value (Rs. Crores)	Contract Completion %
1	1031	...	...	...
2	1032	...	...	...
3	1033	...	...	...
4	1034	...	...	...
5	1035	...	...	...
6	1036	...	...	...
7	1037	...	...	...
8	1038	...	...	...
9	1039	...	...	...
10	1040	...	...	...

26

Sl. No.	Contract No.	Contract Name	Contract Value (Rs. Crores)	Contract Completion %
1	1041	...	...	...
2	1042	...	...	...
3	1043	...	...	...
4	1044	...	...	...
5	1045	...	...	...
6	1046	...	...	...
7	1047	...	...	...
8	1048	...	...	...
9	1049	...	...	...
10	1050	...	...	...

27

Sl. No.	Contract No.	Contract Name	Contract Value (Rs. Crores)	Contract Completion %
1	1051	...	...	...
2	1052	...	...	...
3	1053	...	...	...
4	1054	...	...	...
5	1055	...	...	...
6	1056	...	...	...
7	1057	...	...	...
8	1058	...	...	...
9	1059	...	...	...
10	1060	...	...	...

28

Sl. No.	Contract No.	Contract Name	Contract Value (Rs. Crores)	Contract Completion %
1	1061	...	...	...
2	1062	...	...	...
3	1063	...	...	...
4	1064	...	...	...
5	1065	...	...	...
6	1066	...	...	...
7	1067	...	...	...
8	1068	...	...	...
9	1069	...	...	...
10	1070	...	...	...

29

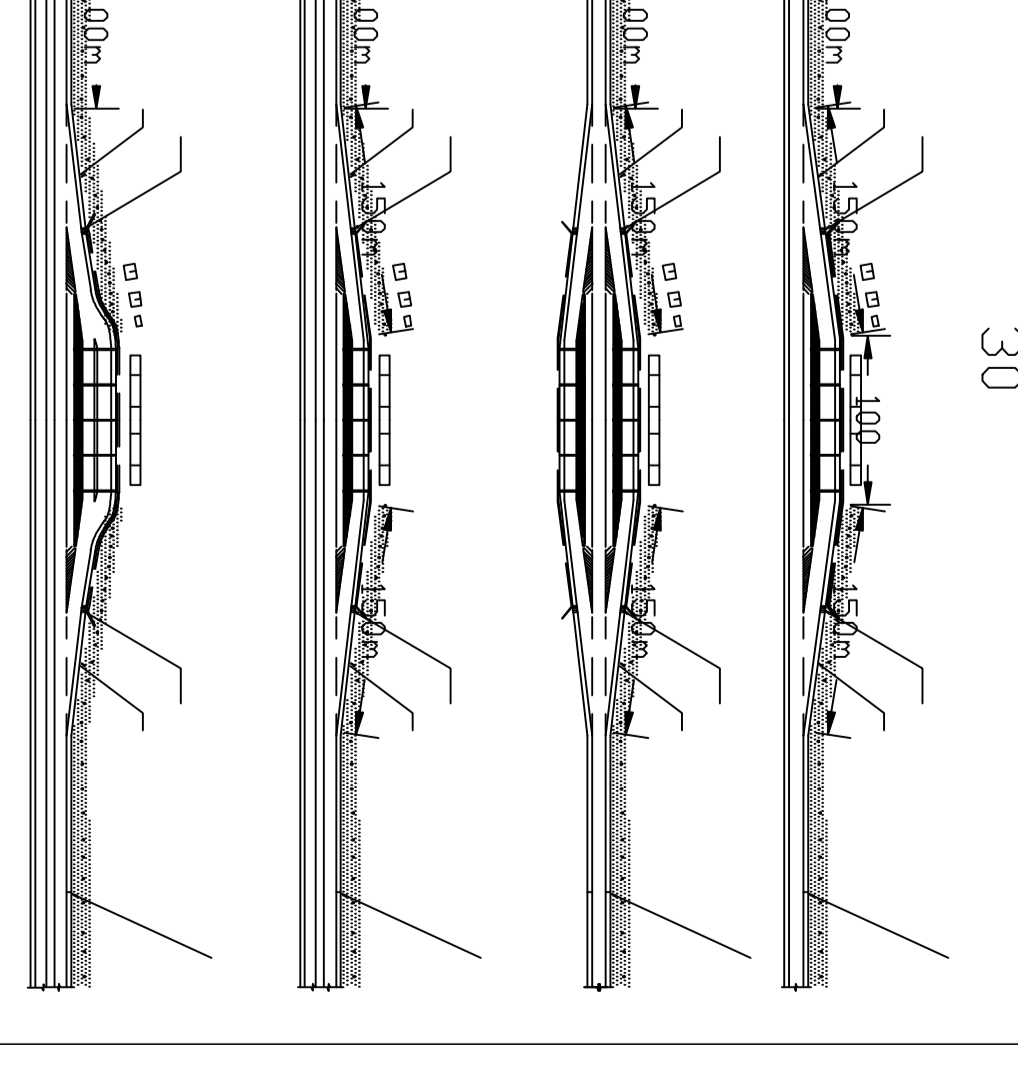

30